

[www.screenroom.at](http://www.screenroom.at)

# OUTDOOR LIVING

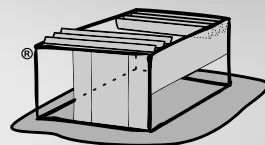

**SCREENROOM**







# OUR PRODUCTS

---

04 Slated roof /  
bioclimatic pergola

---

08 Folding roof

---

12 Pergola

---

14 Zip screen

---

16 Carport

---

18 Glass railing

---

20 Bicycle service station

---

22 Double-decker parker

---



A modern glass pergola with a slated roof is shown over a swimming pool. The pergola has large glass panels and a dark frame. The pool is visible through the glass, and the surrounding area includes a lawn and some landscaping. The sky is blue with some clouds.

More space for  
unforgettable

# SLATED ROOF / BIOCLIMATIC PERGOLA





With our innovative slatted roofs you can transform your garden into an oasis of relaxation! Experience ultimate control over sun and shade while finding peace under the elegant design. Whether it's bright sunshine or gentle rain, you alone determine the atmosphere. Create the perfect space for social gatherings or relaxing outdoor moments.







# FOLDING ROOF

Functionality  
and elegance  
for your home!





Our folding roofs not only protect against wind, rain and UV radiation but also offer a unique outdoor feeling! They can be used flexibly and give you more time outdoors.

**Optional equipment:**

- LED point lighting or LED strips
- Glazing
- Zip screen
- Radiant heaters





Airy protection  
in a beautiful dress

# PERGOLA

Whether as a romantic meeting point or a stylish outdoor living room – our pergolas create a harmonious space in which you can enjoy nature to the fullest. Guarantees you unforgettable moments outdoors.



# ZIP SCREEN

Comfort and versatility  
in perfection



Our tailor-made sun protection solutions not only offer optimal protection from dazzling light and prying eyes, but also impress with their functionality and design. With our zip screens you get control over the room climate and privacy. Discover the future of sun protection and transform your room into a stylish oasis of comfort.



# CAR- PORT

Versatile  
and useful



The tailor-made canopies not only offer first-class protection from sun, rain, wind and snow, but also add an elegant touch to your home.

**Optional accessories:**

- Photovoltaic roof
- Charging station
- LEDs
- Power connections





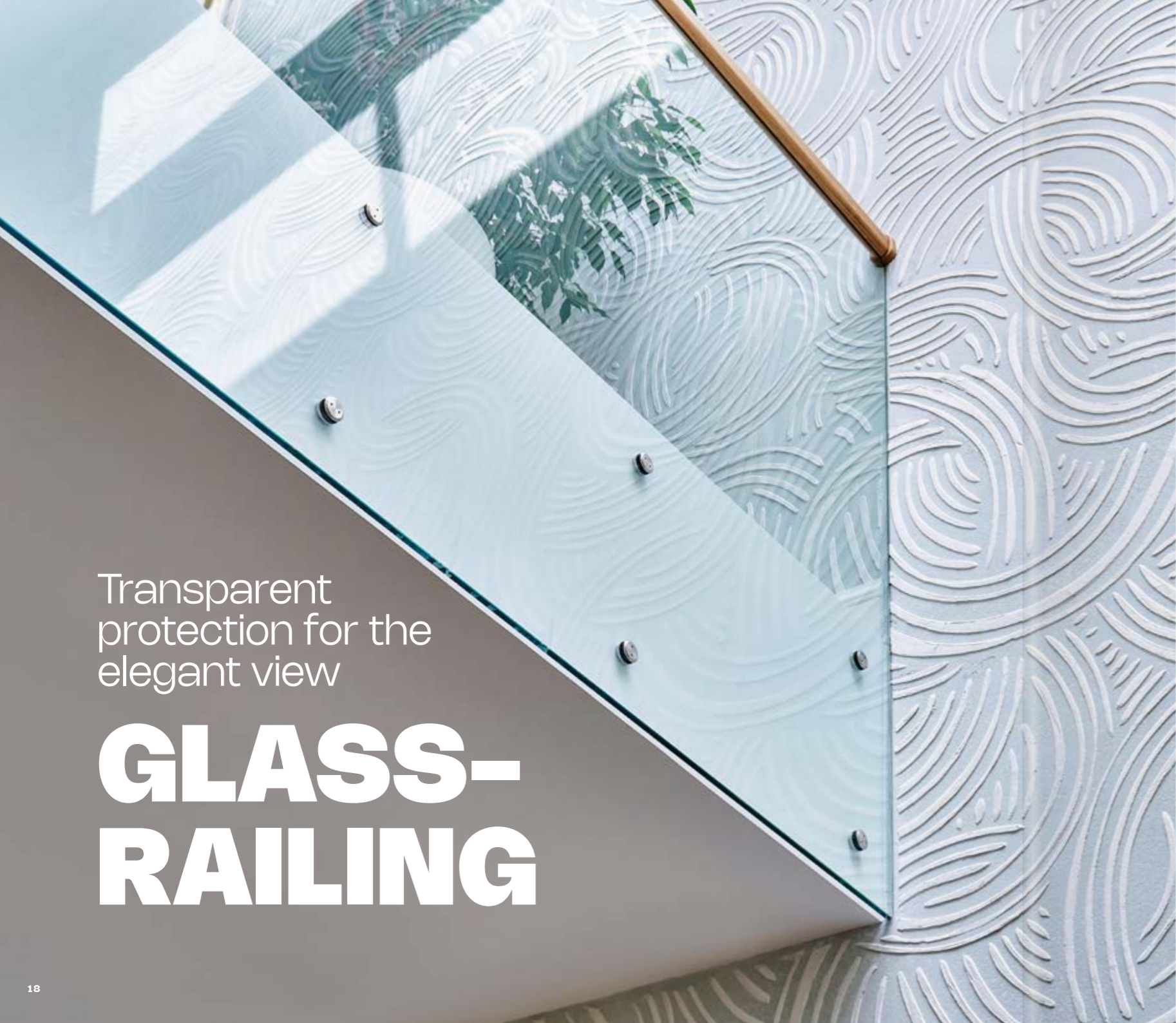

Transparent  
protection for the  
elegant view

# GLASS- RAILING



Discover the beauty and protection  
of our premium glass railings! Whether  
on the terrace or in the living room,  
they offer a clear view, create an open  
atmosphere and at the same time en-  
sure security and stability.





# BICYCLE-SERVICE-STATION



The service station was developed so that in the event of minor damage or breakdowns, repairs to the bike or similar can be carried out so that you can then continue your journey again.



 Adjustable wrench

 Screwdriver

 Air pump

 Pressure gauge

 Wrench

 Tire iron

 Allen key

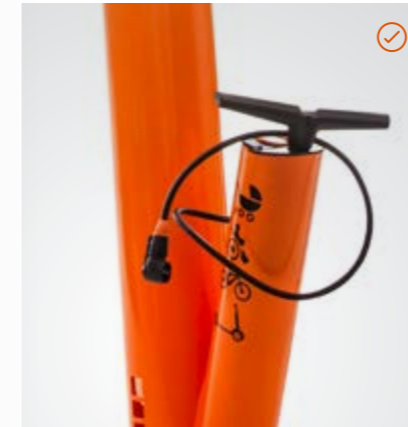

**Air pump** with adapter for the usual valves.

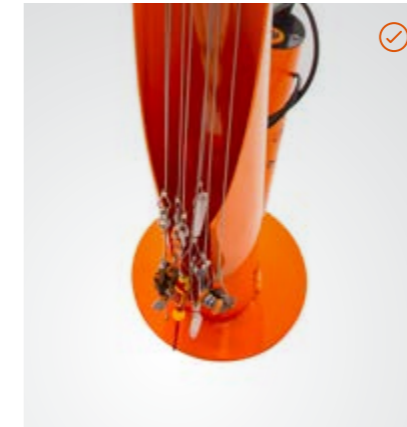

**Tool** are attached using a wire rope.

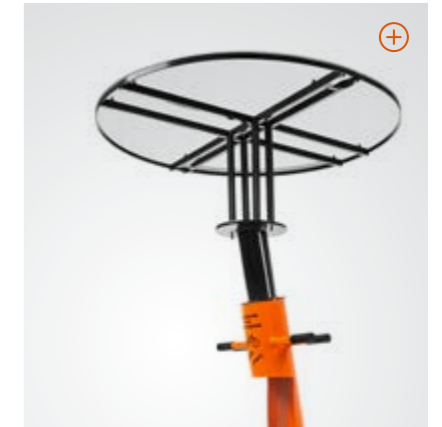

**Roof element** provides protection against rain and hail.

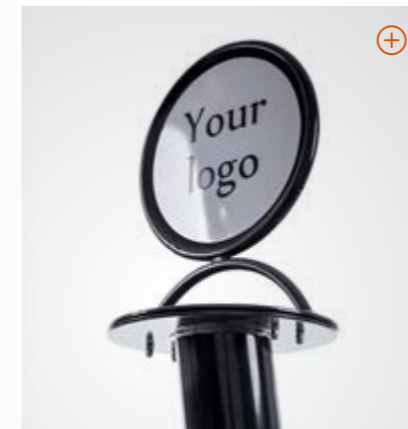

**Advertising opportunity** for images/logos etc.



**Charging options** for e-bikes.

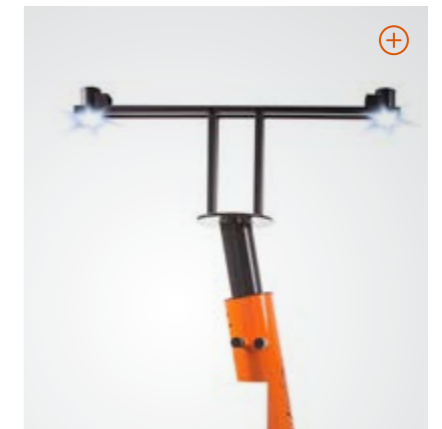

**Lighting** using LED.

 Basic equipment

 Optional equipment



# DOUBLE FLOOR-PARKER



The double-decker parkers make it possible to park twice as many bicycles in the same area. The robust steel construction is perfect for use in companies, residential complexes or public spaces.

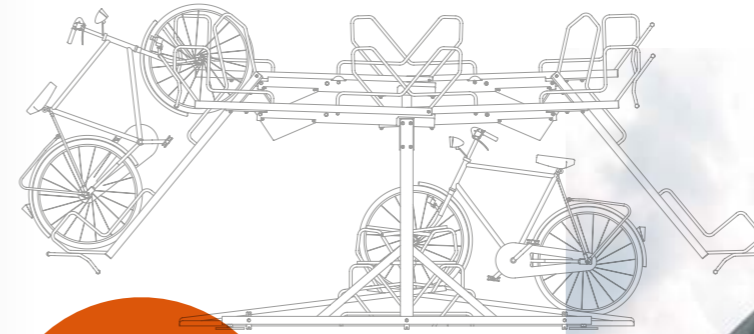

#### Advantages:

- Space-saving, double-level parking
- Easy adjustment thanks to lifting aid
- Systems of any size
- Suitable for tire widths up to 55 mm
- Single or double sided wheel adjustment





## OUR COMPANIES AND PARTNERS

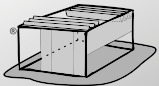

**SCREENROOM**

Tel. +43 7215 39050  
Mitterdavidschlag 4  
4202 Kirchsschlag  
office@screenroom.at  
www.screenroom.at

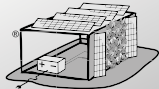

**SCREENROOF**

Tel. +43 7215 39050-12  
Mitterdavidschlag 4  
4202 Kirchsschlag  
office@screenroof.at  
www.screenroof.com

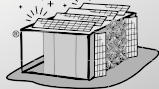

**SCREENCLEAN**

Tel. +43 7215 39050-12  
Mitterdavidschlag 4  
4202 Kirchsschlag  
office@screenroof.at  
www.screenclean.at



Tel. +43 7215 39050-12  
Mitterdavidschlag 4  
4202 Kirchsschlag  
office@screenroof.at  
www.screenwood.at



**HOLDING**

Tel. +43 7215 39050  
Mitterdavidschlag 4  
4202 Kirchsschlag  
thomas@pils.at  
www.pundpholding.at



Tel. +43 7215 39050  
Mitterdavidschlag 4  
4202 Kirchsschlag  
office@screenroom.at  
www.pr-pergola.at



Tel. +43 7215 39050-12  
Mitterdavidschlag 4  
4202 Kirchsschlag  
office@screenroof.at  
www.rescreen.at



Tel. +43 680 24 32 601  
Mitterdavidschlag 4  
4202 Kirchsschlag  
mir@müp.com  
www.müp.com



Tel. +43 7215 39050-12  
Mitterdavidschlag 4  
4202 Kirchsschlag  
my@highlandmeat.at  
www.highlandmeat.at



Tel. +43 7215 39050  
Mitterdavidschlag 4  
4202 Kirchsschlag  
office@screenroom.at  
www.therock-holding.at



Adalbert Stifter Straße 6  
4202 Kirchsschlag  
office@cby.at  
www.cby.at



Tel. +43 677 62 30 95 16  
martin.p@screenroof.at

# REACHING MORE TOGETHER!

We are an innovative collective from different industries, who combine their strengths to achieve even more. Every single company in our network brings unique expertise and passion, to shape a sustainable and progressive future.